

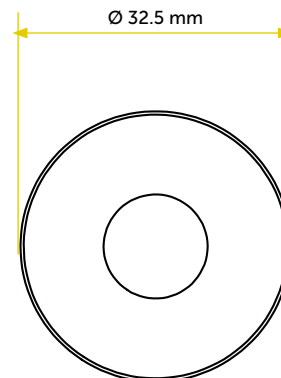

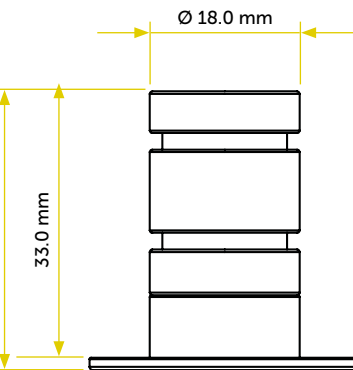



# COIN

Recessed step diffused light



LIGHT SOURCE	
	POWER 1 W
	> 80
	<ul style="list-style-type: none"> <li>▶ 2700K</li> <li>▶ 3000K</li> <li>▶ 4000K</li> </ul>
	RGBW available

OPTIC	
Available accessories	 Anti-glare lid
Available optics	 >60°
Plexiglass	Frosted

FIXTURE	
Body material	Plexiglass
Frame material	<ul style="list-style-type: none"> <li>▶ AISI316L Stainless steel</li> <li>▶ Aluminum 6082</li> <li>▶ Brass</li> </ul>
Frame finish	<ul style="list-style-type: none"> <li>▶ Polishing</li> <li>▶ Anodization</li> <li>▶ Galvanization*</li> <li>▶ Coating</li> </ul> <p style="text-align: right; margin: 0;"><small>*For interiors only</small></p>
IP Rate	IP68
Fixing system	Springs, O-Ring + Bushing

ELECTRICAL FEATURES	
Driver	Integrated
Dimmable	PWM (100 – 500Hz)
Voltage	18 - 32 Vdc
Protections	<ul style="list-style-type: none"> <li>▶ Reverse polarity</li> <li>▶ 500V Spike</li> <li>▶ Interference</li> </ul>

MECHANICAL FEATURES	
Dimensions	Ø 32.5 mm – Recess 33.0 mm
Weight	25 gr
Cut-out	18.0 mm ** <small>**Non-executive measures</small>
Use	Outdoor and Indoor